

MODEL **31-AGM**
 VOLTAGE **12**
 CAPACITY **100Ah @ 20Hr**
 MATERIAL **Polypropylene**
 BATTERY **VRLA AGM / Non-Spillable / Maintenance-Free**
 COLOR **Maroon**
 WATERING **No Watering Required**



12 VOLT

PHYSICAL SPECIFICATIONS

BCI	MODEL NAME	TERMINAL TYPE	DIMENSIONS ^g INCHES (mm)			WEIGHT ^h LBS. (kg)	HANDLES	INSTALLATION ORIENTATION
			LENGTH	WIDTH	HEIGHT ^f			
31	31-AGM	M8/DT				67 (30)	Plastic Handle	Horizontal and Vertical
			12.80 (325)	6.81 (173)	9.37 (238)			

ELECTRICAL SPECIFICATIONS

VOLTAGE	CRANKING PERFORMANCE		CAPACITY ^A MINUTES	CAPACITY ^B AMP-HOURS (Ah)				ENERGY (kWh)	INTERNAL RESISTANCE (mΩ)	SHORT CIRCUIT CURRENT (amps)
	C.C.A. ^D @0°F	C.A. ^E @32°F	@ 25 Amps	5-Hr	10-Hr	20-Hr	100-Hr	100-Hr		
12									4.80	2555
	600	720	177	82	92	100	111	1.33		

CHARGING INSTRUCTIONS

CHARGER VOLTAGE SETTINGS (AT 77°F/25°C)				
SYSTEM VOLTAGE	12V	24V	36V	48V
Maximum Charge Current (A)	20% of C ₂₀			
Absorption Voltage (2.40 V/cell)	14.40	28.80	43.20	57.60
Float Voltage (2.25 V/cell)	13.50	27.00	40.50	54.00

Do not install or charge batteries in a sealed or non-ventilated compartment. Constant under or overcharging will damage the battery and shorten its life as with any battery.

CHARGING TEMPERATURE COMPENSATION

ADD	SUBTRACT
0.005 volt per cell for every 1°C below 25°C 0.0028 volt per cell for every 1°F below 77°F	0.005 volt per cell for every 1°C above 25°C 0.0028 volt per cell for every 1°F above 77°F

OPERATIONAL DATA

OPERATING TEMPERATURE	SELF DISCHARGE
-4°F to 122°F (-20°C to +50°C). At temperatures below 32°F (0°C) maintain a state of charge greater than 60%.	Less than 3% per month depending on storage temperature conditions

RECYCLE RESPONSIBLY

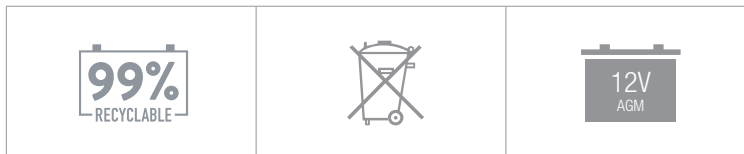

STATE OF CHARGE MEASURE OF OPEN-CIRCUIT VOLTAGE

PERCENTAGE CHARGE	CELL	12 VOLT
100	2.14	12.84
75	2.09	12.54
50	2.04	12.24
25	1.99	11.94
0	1.94	11.64

TROJAN 31-AGM PERFORMANCE

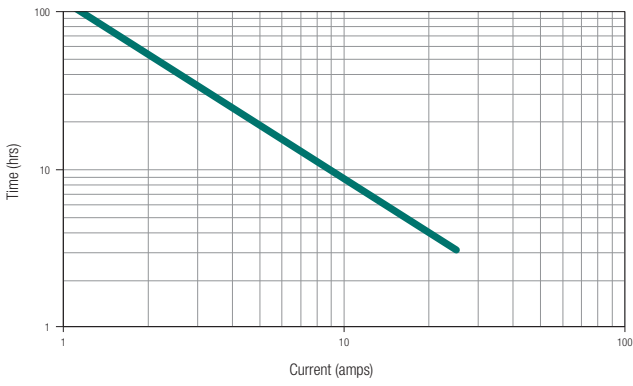

PERCENT CAPACITY VS. TEMPERATURE

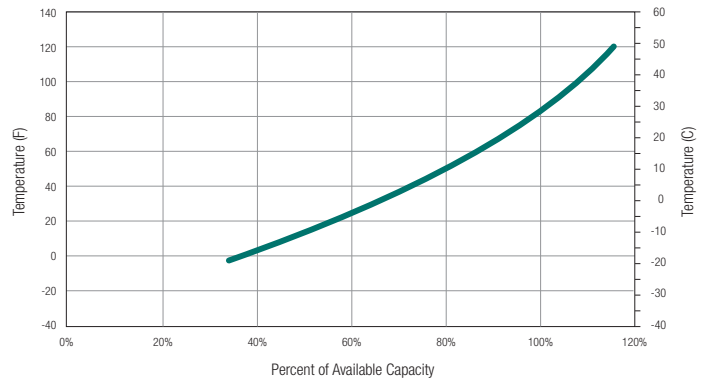

BATTERY DIMENSIONS (shown with DT)

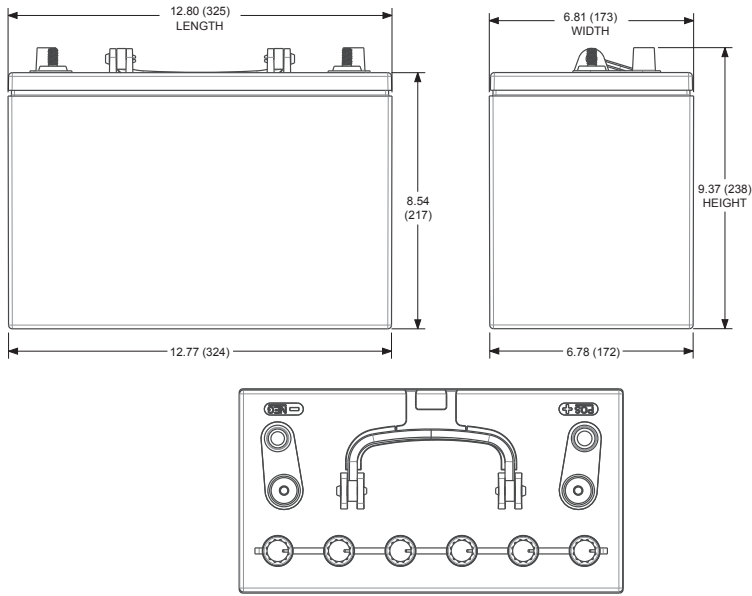

SELF DISCHARGE VS. TIME^H

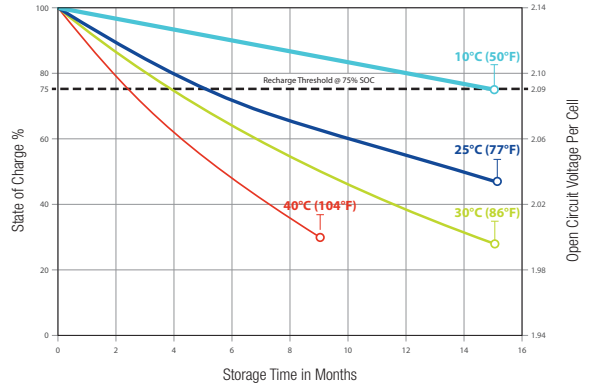

TERMINAL TYPE^G

15	M8	M8
	Battery Height with Terminal in Inches (mm) 8.69 (221) Torque Values in-lb (Nm) Bolt: 85 – 90 (10 – 11)	

6	DT	AUTOMOTIVE POST & STUD
	Battery Height with Terminal in Inches (mm) 9.37 (238) Torque Values in-lb (Nm) Connected to Stud: 95 – 105 (11 – 12) Connected to AP: 50 – 70 (6 – 8) Bolt Size 5/16" – 18	

A. The number of minutes a battery can deliver when discharged at a constant rate at 80°F (27°C) and maintain a voltage above 1.75 V/cell. Capacities are based on peak performance.
 B. The amount of amp-hours (Ah) a battery can deliver when discharged at a constant rate at 80°F (27°C) and maintain a voltage above 1.75 V/cell. Capacities are based on peak performance.
 C. Dimensions may vary depending on type of handle or terminal. Batteries should be mounted with 0.5 inches (12.7 mm) spacing minimum.
 D. C.C.A. (Cold Cranking Amps) - the discharge load in amperes which a new, fully charged battery can maintain for 30 seconds at 0°F (-18°C) at a voltage above 1.2 V/cell.

E. C.A. (Cranking Amps) - the discharge load in amperes which a new, fully charged battery can maintain for 30 seconds at 32°F (0°C) at a voltage above 1.2 V/cell. This is sometimes referred to as marine cranking amps @ 32°F or M.C.A. @ 32°F.
 F. Height taken from bottom of the battery to the highest point on the battery. Heights may vary depending on type of terminal.
 G. Terminal images are representative only.
 H. Batteries in storage should be charged when they decline to 75% State of Charge (SOC).
 I. Weight may vary.



Designed in compliance with applicable BCI, DIN, BS and IEC standards. Tested in compliance to BCI and IEC standards.



800.423.6569 / +1.562.236.3000 / trojanbattery.com

31-AGM_DS_061021

© 2021 Trojan Battery Company, LLC. All rights reserved. Trojan Battery Company is not liable for damages that may result from any information provided in or omitted from this publication, under any circumstances. Trojan Battery Company reserves the right to make adjustments to this publication at any time, without notice or obligation.